

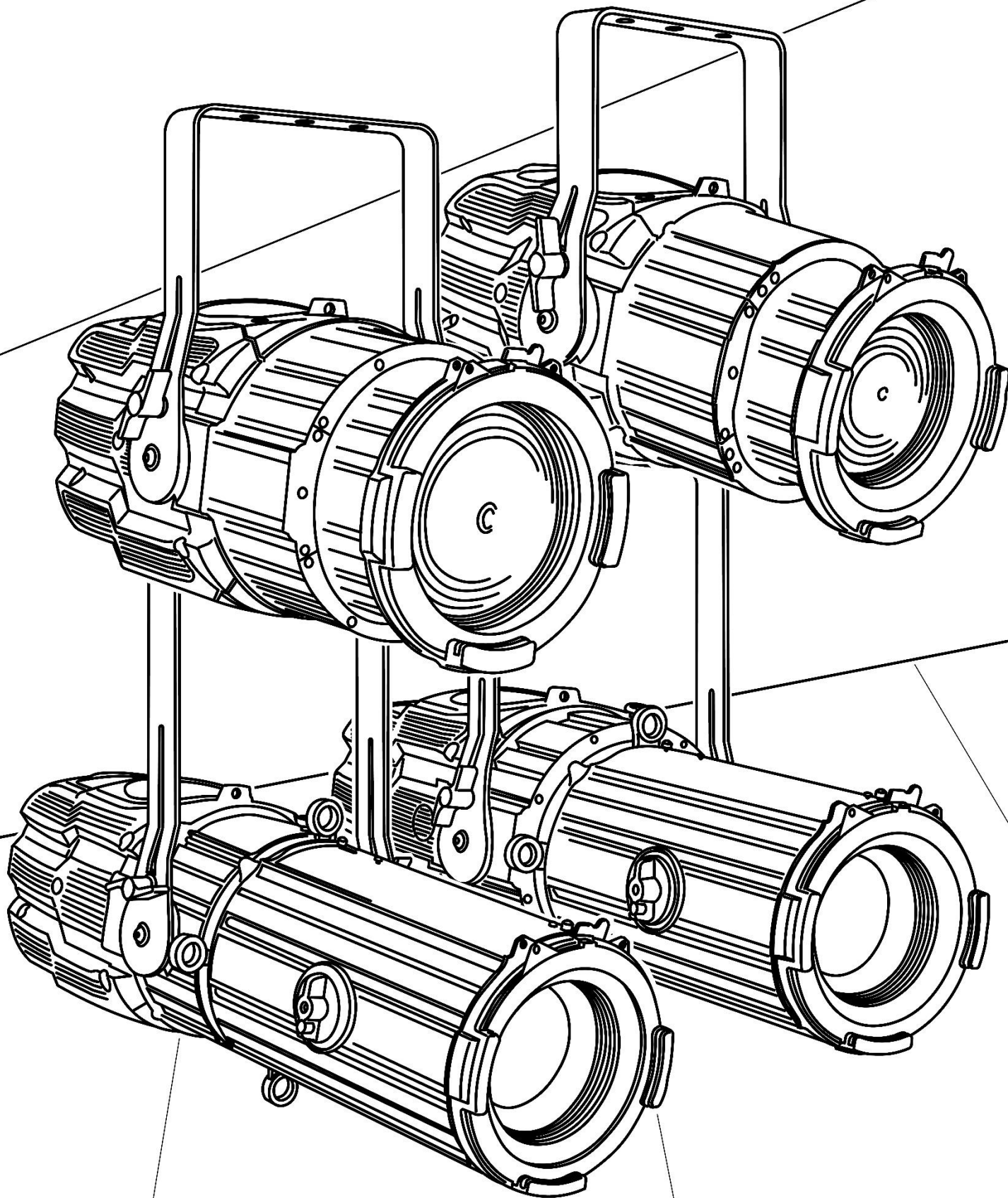

TENORE SOPRANO WH

RDM-DMX MANUAL



Release	1.0	Code: 05171370	For more information	
Language	EN			

All other trademarks, both marked and not marked, are the property of their respective owners.

ITA

Le informazioni contenute in questo documento sono state attentamente redatte e controllate. Tuttavia non è assunta alcuna responsabilità per eventuali inesattezze. Tutti i diritti sono riservati e questo documento non può essere copiato, fotocopiato, riprodotto per intero o in parte senza previo consenso scritto della D.T.S. Illuminazione.

D.T.S. Illuminazione si riserva il diritto di apportare senza preavviso cambiamenti e modifiche estetiche funzionali o di design a ciascun proprio prodotto. D.T.S. Illuminazione non assume alcuna responsabilità sull'uso o sull'applicazione dei prodotti o dei circuiti descritti.

ENG

The information contained in this publication has been carefully prepared and checked. However, no responsibility will be taken for any errors. All rights are reserved and this document cannot be copied, photocopied or reproduced, in part or completely, without prior written consent from D.T.S. Illuminazione

D.T.S. Illuminazione reserves the right to make any aesthetic, functional or design modifications to any of its products without prior notice. D.T.S. Illuminazione takes no responsibility for the use or application of the products or circuits described herein.

FRA

Les informations contenues dans le présent manuel ont été rédigées et contrôlées avec le plus grand soin. Nous déclinons toutefois toute responsabilité en cas d'éventuelles inexactitudes. Tous droits réservés. Ce document ne peut être copié, photocopié ou reproduit, dans sa totalité ou partiellement, sans le consentement préalable de D.T.S. Illuminazione.

D.T.S. Illuminazione se réserve le droit d'apporter toutes modifications et améliorations esthétiques, fonctionnelles ou de design, sans préavis, à chacun de ses produits. D.T.S. Illuminazione décline toute responsabilité sur l'utilisation ou sur l'application des produits ou des circuits décrits.

ESP

Las informaciones contenidas en este documento han sido cuidadosamente redactadas y controladas. Con todo, no se asume ninguna responsabilidad por eventuales inexactitudes. Todos los derechos han sido reservados y este documento no puede ser copiado, fotocopiado o reproducido, total o parcialmente, sin previa autorización escrita de D.T.S. Illuminazione.

D.T.S. Illuminazione se reserva el derecho a aportar sin previo aviso cambios y modificaciones de carácter estético, funcional o de diseño a cada producto suyo. D.T.S. Illuminazione no se asume responsabilidad de ningún tipo sobre la utilización o sobre la aplicación de los productos o de los circuitos descritos.

Table of Contents

1	DMX Signal Connection	4
1.1	DMX Modes	5
1.2	Setting Up the DMX Address	5
2	RDM Functions.....	5
3	Updating the Firmware	8
4	Display Functions	9
4.1	Jog Wheel	9
5	Error Messages	12
6	DMX Protocol	13
6.1	DMX Personality 1	13
6.2	DMX Personality 2	14
6.3	DMX Personality 3	15
	NOTES	16

1 DMX Signal Connection

- The unit operates using the digital USITT DMX512 signal.
- Connection between the light controller and the projector, or between projectors, must be carried out using a two-pair screened \varnothing 0.5 mm cable, and a XLR 5 or 3 pins connector.
- Ensure that the conductors do not touch each other. Do not connect the ground cable to the XLR chassis. The housing of the plug must be isolated.
- Connect the light controller to the DMX IN panel connector of the projector; to create a link to the next projector, simply connect the DMX OUT plug of the former to the DMX IN plug of the new fixture in line. Following this procedure, all the projectors will be cascade connected.

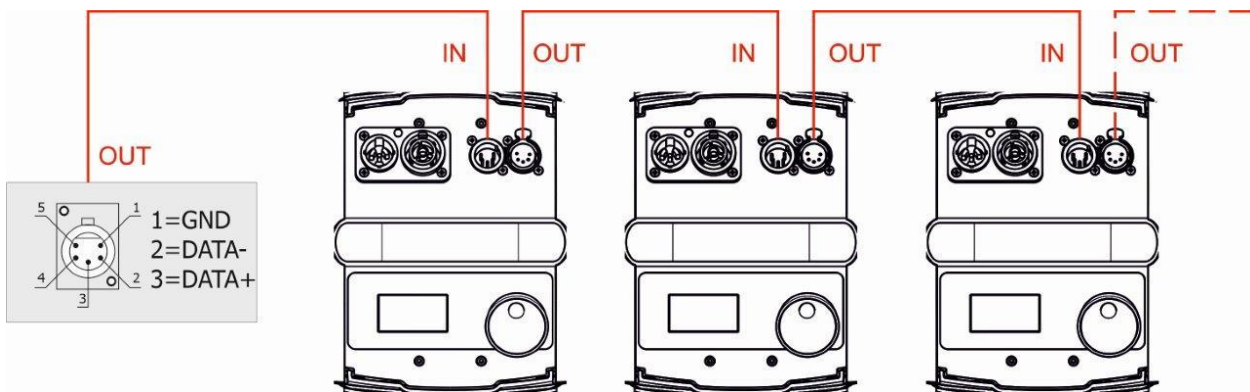

PS. If the display showing the DMX address flashes, then one of the following errors has occurred:

- DMX signal not present
- DMX reception problem

The use of a DMX terminator is recommended.

The DMX terminator is a male XLR 3- or 5-pins connector with a 120 Ω resistor between pin 2 and pin 3.

The DMX terminator must be plugged in into the last unit's DMX OUT panel connector of the DMX line.

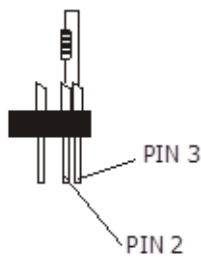
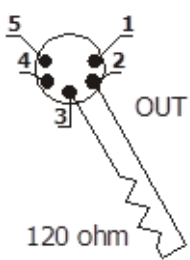

Place a 120 Ω resistor between pin 2 and 3 of a male XLR connector;

Plug the resistor into the DMX OUT panel connector of the last unit connected to the DMX line.

1.1 DMX Modes

TENORE 3/5 SOPRANO 3/5 can be used in three different DMX modes:

- “4ch” (Default) – Shutter, Dimmer 16bit and Fixture Control channel.
- “1ch” – Dimmer 8bit
- “Fine” – Dimmer 16bit.

e.g., when using the unit in “4ch” (Default) mode, set the following addresses on the light desk:

Projector 1	A001	
Projector 2	A005	<i>If you want to select the next projector, just add “4” to the former DMX address</i>
Projector 3	A009	
.....	A....	
Projector 6	A021	

1.2 Setting Up the DMX Address

- 1 Rotate the jog wheel until you reach the desired DMX address. The numbers on the display will start flashing (new DMX address hasn't yet been set).
- 2 Push to confirm your selection. The numbers on the display will stop flashing; the projector is now set to the new DMX address.

2 RDM Functions

By using a RDM controller, it is possible to read/set DMX addresses, DMX modes and other parameters.

TENORE 3/5 - SOPRANO 3/5 accepts the following RDM commands:

RDM version: ANSI E1.20 –2010

RDM Device Model ID			
0710:0D95xxxx (Tenore/Soprano 3)			
0710:0D94xxxx (Tenore/Soprano 5)			
RDM PID DESCRIPTION	RDM PID VALUE	GET	SET
Category - Network Management			
DISC_UNIQUE_BRANCH	0x0001		
DISC_MUTE	0x0002		
DISC_UN_MUTE	0x0003		
Category - Status Collection			
STATUS_MESSAGES	0x0030	X	
STATUS_ID_DESCRIPTION	0x0031	X	
Category - RDM Information			
SUPPORTED_PARAMETERS	0x0050	X	
PARAMETERS_DESCRIPTION	0x0051	X	
Category - Product Information			
DEVICE_INFO	0x0060	X	
DEVICE_MODEL_DESCRIPTION	0x0080	X	
MANUFACTURER_LABEL	0x0081	X	
DEVICE_LABEL	0x0082	X	X

SOFTWARE_VERSION_LABEL	0x00C0	X	
Category - DMX512 Setup			
DMX_PERSONALITY	0x00E0	X	X
DMX_PERSONALITY_DESCRIPTION	0x00E1	X	
DMX_START_ADDRESS	0x00F0	X	X
Category - Sensors			
SENSOR_DEFINITION	0x0200	X	
SENSOR_VALUE	0x0201	X	X
Category - Dimmer Settings			
CURVE	0x0343	X	X
CURVE_DESCRIPTION	0x0344	X	
OUTPUT_RESPONSE_TIME	0x0345	X	X
OUTPUT_RESPONSE_TIME_DESCRIPTION	0x0346	X	
MODULATION_FREQUENCY	0x0347	X	X
MODULATION_FREQUENCY_DESCRIPTION	0x0348	X	
Category - Power/Lamp Settings			
DEVICE_HOURS	0x0400	X	
LAMP_HOURS	0x0401	X	
Category - Display Settings			
DISPLAY_INVERT	0x0500	X	X
Category - Control			
IDENTIFY_DEVICE	0x1000	X	
Category - Custom PID			
NO DMX ACTION	0x9002	X	X
FANS SETTING	0x903A	X	X
DISPLAY STANDBY	0x903C	X	X

FURTHER RDM MESSAGES:

CURVE	CURVE DESCRIPTION
1	LINEAR
2	QUADRATIC (default)
3	S-CURVE
4	GAMMA 2.2

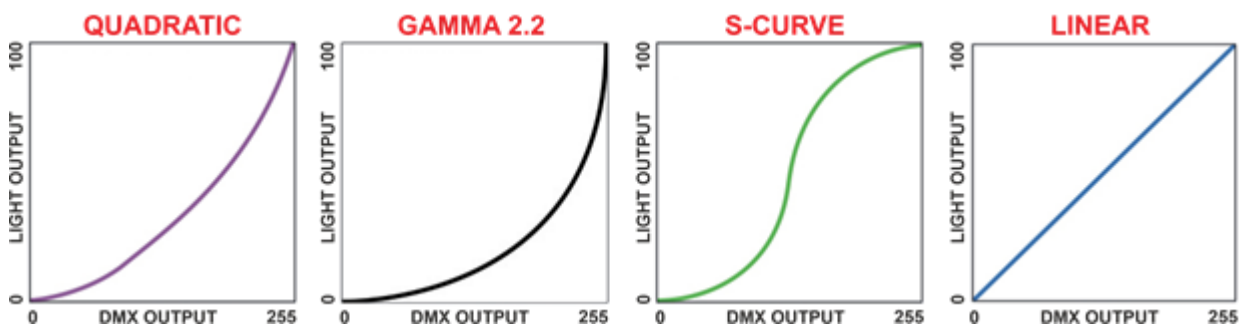
“GAMMA CORR.” graphics:

OUTPUT RESPONSE TIME	OUTPUT_RESPONSE_TIME_DESCRIPTION
0	SMOOTH OFF
1	SMOOTH 1 (25 ms)
2	SMOOTH 2 (50 ms)
3	SMOOTH 3 (75 ms)
4	SMOOTH 4 (100 ms) (default)
5	SMOOTH 5 (125 ms)
6	SMOOTH 6 (150 ms)
7	SMOOTH 7 (175 ms)
8	SMOOTH 8 (200 ms)
9	SMOOTH 9 (225 ms)
10	SMOOTH 10 (250 ms)
11	SMOOTH 11 (275 ms)
12	SMOOTH 12 (300 ms)
13	SMOOTH 13 (325 ms)
14	SMOOTH 14 (350 ms)
15	SMOOTH 15 (375 ms)
16	SMOOTH 16 (400 ms)
17	SMOOTH 17 (425 ms)
18	SMOOTH 18 (450 ms)
19	SMOOTH 19 (475 ms)
20	SMOOTH 20 (500 ms)

FURTHER RDM MESSAGES:

MODULATION FREQUENCY	MODULATION FREQUENCY DESCRIPTION
1	610 Hz
2	800 Hz
3	1.000 Hz (default)
4	1.500 Hz
5	2.000 Hz
6	2.500 Hz
7	3.000 Hz
8	3.500 Hz
9	4.000 Hz
10	4.500 Hz
11	5.000 Hz

RDM MANUFACTURER'S SPECIFIC PIDs:

RDM CUSTOM PID	DESCRIPTION
FANS SETTING	0: Fan mode STANDARD 1: Fan mode SILENT (DEFAULT) 2: Fan mode ULTRA-SILENT 3: Fan mode AUTO
NO DMX ACTION	1: KEEP LAST (DEFAULT) 2: BLACKOUT 3: 60% 4: SINGLE CUE
DISPLAY_STANDBY	0 = DISABLED 1 = ENABLED (DEFAULT) 2 = FORCED ENABLED

RDM STATUS MESSAGE IDs:

Status Message ID	Data Value 1	Data Value 2	Status ID Description
0x8008			ERROR SUPPLY VOLTAGE TOO LOW
0x8009			ERROR SUPPLY VOLTAGE TOO HIGH
0x801F			ERROR TEMPERATURE LED MODULE
0x8021			ERROR TEMPERATURE MICRO

3 Updating the Firmware

In order to update the unit to the latest firmware release, you will need:

- DTS firmware uploader dongle (code 03.LA.206).
- “DTS Firmware Upgrade Utility” program (v.2.02 or later) installed on PC (Windows OS).
- Latest firmware release available for the unit.

Updating to the latest firmware release:

To perform the update, please follow the procedure as described below:

- 1 Connect the DTS Firmware Uploader Dongle to a spare USB port on the PC.
- 2 Connect the unit’s DMX IN to the DTS Firmware Uploader Dongle’s DMX OUT with a standard DMX cable and turn on the fixture.
- 3 Send the new firmware release into the unit by using “DTS Firmware Upgrade Utility” program.

During software upgrade the leds will blink.

At the end of the procedure, the unit will reboot.

For more information, please refer to an authorized DTS service center.

4 Display Functions

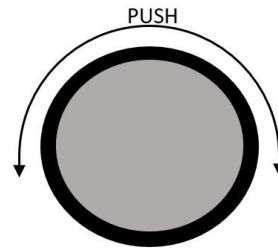

The display panel shows all the available control menus.





You can access the menus by clicking the jog wheel.

Turning the jog wheel performs cycling through the menus.

By selecting the available functions on these menus, you will be able to change the fixture's settings and behavior.

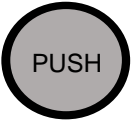
Beware that changing these settings may vary the operating functions of the unit so that it may not respond correctly to the signal given to it. Carefully read the instructions and tables below before carrying out any variations or selections.

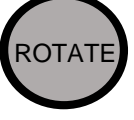
4.1 Jog Wheel

 PUSH LongPress>1s	<ul style="list-style-type: none"> • To access the control menus on display panel. • To return to the previous level in the menu structure without making a change. • To exit the menus.
 PUSH Short Press<1S	<ul style="list-style-type: none"> • To select any required menu. • To confirm any changes.
 ROTATE Cw/Ccw	<ul style="list-style-type: none"> • To navigate the menu's structure. • To change or scroll between any values.
 PUSH Long Press>3s	<ul style="list-style-type: none"> • To return to DMX Address visualization from any menu, without making a change.



FIRMWARE RELEASE	1.00
RDM Device Model ID	0710:0D95xxxx (Tenore/Soprano 3) 0710:0D94xxxx (Tenore/Soprano 5)
DMX Personality IDs	0x01 “CCT” 0x02 “BASIC”

MAIN MENU	LEVEL 1	LEVEL 2	LEVEL 3	FUNCTION
DISPLAY	FLIP	DISABLED / ENABLED / BACK		Reverses display's reading depending on the mounting position. Default = DISABLED
	STANDBY	DISABLED / ENABLED / FORCED ENABLED / BACK		DISABLED: Display stand-by disabled (Default) . - ENABLED: Display goes OFF after 10 seconds. -FORCED ENABLED: Display forced OFF even if control signal is missing or error messages are shown.
	BACK			Back to Main Menu
MODE (DMX personalities)	4CH		Allows to select 4CH mode	Default. Shutter, Dimmer 16bit and Fixture Control channel.
	1CH		Allows to select 1CH mode	Dimmer 8bit
	FINE		Allow to select FINE mode	Dimmer 16bit
	BACK			Back to Main Menu
LED	SMOOTH	OFF / 1..20 / BACK		Allows to select the value of delay (in ms) for DIMMER channel reaction to DMX dimming command. OFF = Instant response. 4 = 100 ms smooth response (Default). 20 = 500 ms smooth response.
	GAMMA CORR.	QUADRATIC		Allows to set quadratic current output for LED (Default) . See “Gamma Correction” graphics for details.
		GAMMA 2.2		Allows to set gamma curve 2.2 current output. See “Gamma Correction” graphics for details.
		S-CURVE		Allows to set S-curve to emulates light intensity characteristics of the tungsten halogen lamps. See “Gamma Correction” graphics for details.
		LINEAR		Allows to set linear light output. See “Gamma Correction” graphics for details.
		BACK		
	FREQUENCY	610 - 5000 HZ / BACK		Allows to adjust the PWM frequency value (Hz) in order to reduce flickering in the process of camera recordings. Range = 610 Hz – 5 KHz Default = 1000 Hz
BACK			Back to Main Menu	
NO DMX ACTION	Allows to set the desired unit's behavior in case DMX signal is missing or not available.			
	KEEP LAST DMX			Keep last valid DMX signal (Default).
	BLACK OUT			BLACK OUT
		HOLD	1...3600 sec	Hold time keeping last valid DMX signal before to go in black out. Default=1s
60 PERCENT			Light ON @60% Power	

	SINGLE CUE			Single Cue with values selectable by user in "Manual Control > Single Cue" menu
	BACK			Back to Main Menu
MANUAL CONTROL	Manual Control forces the fixture to Dmx Personality 1 – 4CH. DMX input signal is ignored. If MASTER=DISABLED no parameters are transmitted via DMX Line. If MASTER=ENABLED and no DMX is received, the fixture will transmit parameters on DMX line to the "SLAVE" units. In case of MASTER enabled when DMX line is busy, error message "DMX LINE BUSY" will appear on display. When the Fixture is in MANUAL CONTROL>SINGLE CUE, In case of a power cycling, the fixture do restart in MANUAL CONTROL>SINGLE CUE.			
	SINGLE CUE Dmx Pers 1: 4CH	Single Cue with parameters selectable by user		
		SHUTT	0..255	Default = 015
		DIM MSB	0..255	Default = 255
		DIM LSB	0..255	Default = 255
	BACK		Back to Manual Control menu	
MASTER	DISABLE / ENABLED / BACK	SURE (YES / NO) .. DMX LINE BUSY	If MASTER=ENABLED and no DMX is received, the fixture will transmit parameters on DMX line for "SLAVE" units. In case of MASTER enabled when DMX line is busy, error message "DMX LINE BUSY" will appear on display.	
ESC			Exit from Manual control	
SLAVE	Slave mode forces the fixture to Dmx Personality 1 – 4CH and DMX ADDR=1. When Slave mode is selected, In case of a power cycling the fixture do restart in SLAVE mode.			
	SURE	YES	SLAVE MODE ON	Slave Mode active; fixture forced to DMX personality "Basic" and DMX address 001.
		NO	ESC	Exit from Slave Mode
			Back to main menu	
FAN	Standard / Silent / Ultra Silent: Fan Speed is constant. Auto: Variable fans speed depending on detected temperature for Led module and led driver.			
	STANDARD / SILENT / ULTRA SILENT / AUTO / BACK		Tenore / Soprano 3: Fan Standard: 24dBA @ 1m (100% power) Fan Silent: 23dBA @ 1m (100% power) Fan Ultra Silent: 22dBA @ 1m (95% power) Tenore / Soprano 5: Fan Standard: 30dBA @ 1m (100% power) Fan Silent: 26dBA @ 1m (100% power) Fan Ultra Silent: 25dBA @ 1m (90% power) Tenore / Soprano all models: Auto: (100% power). t < 40°C: fans OFF. 40°C < t < 75°C: fans from min to max speed. Default=Silent	
DEFAULT SET	SURE?	YES		To restore Factory Settings.
		NO		Exit without restoring Factory Settings.
SYSTEM INFO	TEMPERATURE	LED 25,0 MICRO 25,0		LED: LED temperature monitoring. MICRO: Micro controller temperature monitoring.
	SOFTWARE	V.1.00		Firmware release
	TIME COUNTERS	LED 00001 UNIT LIFE 00001 Hrs		Unit and LED life time.
	RDM INFO	RDM DEVICE ID: 0710:0D95xxxx / 0710:0D94xxxx		RDM ids
	BACK			Back to main menu
EXIT				Exit from Main Menu

“GAMMA CORR.” graphics:

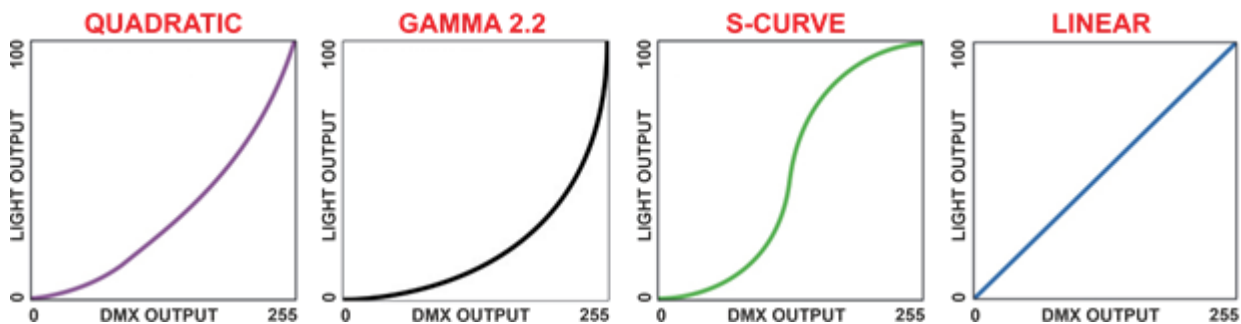

5 Error Messages

ERROR SHOWN ON DISPLAY	APPEARS WHEN
DMX NOT PRESENT	DMX signal missing or DMX cable not connected
TEMP. LED MOD.	LED module temperature detected under -20°C or over 80°C. Unit immediately goes in black-out.
TEMP. MICRO	Micro controller on LED Driver PCB temperature detected under -20°C or over 75°C. Unit immediately goes in black-out.
SUPPLY VOLTAGE TOO LOW	PCBs input voltage <46,5Vdc.
SUPPLY VOLTAGE TOO HIGH	PCBs input voltage >49,5Vdc.

6 DMX Protocol

6.1 DMX Personality 1

DMX Personality 1: "4CH" mode (default)

1. SHUTTER
2. DIMMER Msb
3. DIMMER Lsb
4. FIXTURE CONTROL

1		SHUTTER
DMX value	Function	
000-009	Black Out	
010-019	Open	
020-029	Black Out	
030-119	Strobe (from 3,27s to 30ms)	
120-149	Pulse up (from 42,6s to 120ms)	
150-179	Pulse down (from 42,6s to 120ms)	
180-189	Random strobe	
190-255	Open	

2		DIMMER Msb
DMX value	Function	
000-255	Master dimmer Msb intensity	

3		DIMMER Lsb
DMX value	Function	
000-255	Master dimmer Lsb intensity	

4		FIXTURE CONTROL
DMX value	Function	
000-009	No effect	
010-024	SMOOTH DIMMING OFF	
025-026	SMOOTH DIMMING 1	
027-028	SMOOTH DIMMING 2	
029-030	SMOOTH DIMMING 3	
031-032	SMOOTH DIMMING 4 (Default)	
033-034	SMOOTH DIMMING 5	
035-036	SMOOTH DIMMING 6	
037-038	SMOOTH DIMMING 7	
039-040	SMOOTH DIMMING 8	
041-042	SMOOTH DIMMING 9	
043-044	SMOOTH DIMMING 10	
045-046	SMOOTH DIMMING 11	
047-048	SMOOTH DIMMING 12	
049-050	SMOOTH DIMMING 13	
051-052	SMOOTH DIMMING 14	
053-054	SMOOTH DIMMING 15	
055-056	SMOOTH DIMMING 16	
057-058	SMOOTH DIMMING 17	
059-060	SMOOTH DIMMING 18	
061-062	SMOOTH DIMMING 19	
063-064	SMOOTH DIMMING 20	
065-066	GAMMA CORRECTION QUADRATIC (Default)	
067-068	GAMMA CORRECTION LINEAR	
069-070	GAMMA CORRECTION S-CURVE	
071-072	GAMMA CORRECTION 2.2	
073-084	reserved	

4	FIXTURE CONTROL
DMX value	Function
085-104	OUTPUT FREQUENCY 610 Hz
105	OUTPUT FREQUENCY 800 Hz
106	OUTPUT FREQUENCY 1000 Hz (Default)
107	OUTPUT FREQUENCY 1500 Hz
108	OUTPUT FREQUENCY 2000 Hz
109	OUTPUT FREQUENCY 2500 Hz
110	OUTPUT FREQUENCY 3000 Hz
111	OUTPUT FREQUENCY 3500 Hz
112	OUTPUT FREQUENCY 4000 Hz
113	OUTPUT FREQUENCY 4500 Hz
114	OUTPUT FREQUENCY 5000 Hz
115-154	reserved
155-156	DISPLAY STANDBY DISABLED
157-158	DISPLAY STANDBY ENABLED (Default)
159-160	DISPLAY STANDBY FORCED ENABLED
161-174	reserved
175-176	NO DMX ACTION – KEEP LAST DMX (Default)
177-178	NO DMX ACTION – BLACK OUT
179-180	reserved
181-182	NO DMX ACTION – LED @ 60%
183-184	NO DMX ACTION – SINGLE CUE values selectable via “MANUAL CONTROL> SINGLE CUE menu
185-234	reserved
235-236	FAN MODE SILENT (Default)
237-238	FAN MODE STANDARD
239-240	FAN MODE ULTRA SILENT
241-242	reserved
243-244	FAN MODE AUTO
245-252	reserved
253-255	SET FUNCTION TO DEFAULT: -SMOOTH DIMMING = 4 -GAMMA = QUADRATIC -FREQUENCY = 1000 Hz -DISPLAY STANDBY = ENABLED -NO DMX ACTION = KEEP LAST DMX -FAN MODE = SILENT

6.2 DMX Personality 2

DMX Personality 2: “1CH” mode

1 DIMMER

1	DIMMER
DMX value	Function
000-255	Master dimmer intensity

6.3 DMX Personality 3

DMX Personality 3: "FINE" mode

- 1 DIMMER Msb
- 2 DIMMER Lsb

1	DIMMER Msb
DMX value	Function
000-255	Master dimmer Msb intensity

2	DIMMER Lsb
DMX value	Function
000-255	Master dimmer Lsb intensity

NOTES

ISO 9001:2015

DTS quality system is
certified to the ISO
9001:2015 standard.

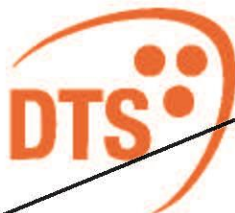

**ITALIAN
PROFESSIONAL
LIGHTING**

D.T.S. Illuminazione S.r.l.
via Fagnano Selve, 12/14
47843 Misano adriatico (RN) Italy
+39 0541 611131
www.dts.lighting - info@dts-lighting.it