

**GigaCore 20t**

# **SAFETY INSTRUCTIONS & QUICKSTART GUIDE**

**GIGACORE PRODUCT FAMILY**  
GigaCore 16t/18t/20t Range

THANKS FOR CHOOSING LUMINEX

**MADE IN BELGIUM**

# SAFETY INSTRUCTIONS

## IMPORTANT SAFETY INSTRUCTIONS:

- Read these instructions.
- Keep these instructions.
- Pay attention to all warnings.
- Follow all instructions.
- Do not use this apparatus near water.
- Clean only with dry cloth.
- Do not block any ventilation openings. Install in accordance with the manufacturer's instructions.
- Do not install near any heat sources such as radiators, heat registers, stoves, or other apparatus (including amplifiers) that produce heat.
- Protect the power cord from being walked on or pinched particularly at plugs, convenience receptacles, and the point where they exit from the apparatus.
- Only use attachments/accessories specified by the manufacturer.
- Unplug this apparatus during lightning storms or when unused for long periods of time.
- Refer all servicing to qualified service personnel. Servicing is required when the apparatus has been damaged in any way, such as power-supply cord or plug is damaged, liquid has been spilled or objects have fallen into the apparatus, the apparatus has been exposed to rain or moisture, does not operate normally, or has been dropped.

### APPARATUS WITH MAINS POWER CONNECTION MUST BE EARTHED



**WARNING:** Avoid electric shock and fire hazard! Do not defeat the safety purpose of the polarized or grounding-type plug. A polarized plug has two blades with one wider than the other. A grounding type plug has two blades and a third grounding prong. The wide blade or the third prong are provided for your safety. If the provided plug does not fit into your outlet, consult an electrician for replacement of the obsolete outlet.

## PRÉCAUTIONS CONCERNANT LA SÉCURITÉ :

- Lire ces instructions.
- Conserver ces instructions.
- Tenir compte de tous les avertissements.
- Suivre toutes les instructions.
- Ne pas utiliser ce produit à proximité d'eau.
- Nettoyer uniquement avec un chiffon propre et sec.
- Ne pas bloquer les orifices de ventilation. Installer l'appareil conformément aux instructions du fabricant.
- Ne pas installer l'appareil à proximité d'une source de chaleur comme un radiateur, une bouche de chaleur, un poêle ou tout autre appareil (y compris un amplificateur) produisant de la chaleur.
- Acheminer les cordons d'alimentation de sorte qu'ils ne soient pas piétinés ni coincés, en faisant tout spécialement attention aux fiches, prises de courant et au point de sortie de l'appareil.
- Utiliser exclusivement les fixations et accessoires spécifiés par le fabricant.
- Débrancher l'appareil en cas d'orage ou lorsqu'il doit rester hors service pendant une période prolongée.
- Confier toute réparation à un personnel qualifié. Faire réparer l'appareil s'il a subi tout dommage, par exemple si la fiche ou le cordon d'alimentation est endommagé, si du liquide a coulé ou des objets sont tombés à l'intérieur de l'appareil, si l'appareil a été exposé à la pluie ou à de l'humidité, si l'appareil ne fonctionne pas normalement ou est tombé.

### APPAREIL AVEC TENSION PRINCIPALE DOIT ÊTRE MIS À LA TERRE



**AVERTISSEMENT :** Evitez les décharges électriques et les risques d'incendie. Ne pas modifier le système de sécurité de la fiche polarisée ou de la fiche de terre. Une fiche polarisée dispose de deux broches dont une est plus large que l'autre. Une fiche de terre dispose de deux broches et d'une troisième pour le raccordement à la terre. Cette broche plus large ou cette troisième broche est destinée à assurer la sécurité de l'utilisateur. Si la fiche équipant l'appareil n'est pas compatible avec les prises de courant disponibles, faire remplacer les prises par un électricien.



**SWEDEN:** Apparaten skall anslutas till jordat uttag

**NORWAY:** Apparatet må tilkoples jordet stikkontakt

**FINLAND:** Laite on liitettävä suojamaadoituskoskettimilla varustettuun pistorasiaan

**DENMARK:** Apparatets stikprop skal tilsluttes en stikkontakt med jord, som giver forbindelse til stikproppens jord

## VENTILATION OPENINGS:

The system heat vents, located at the front and the rear, dissipate heat. Do not block these openings. Leave at least 5 inches of space at the front and the rear of the switch for proper ventilation. Be reminded that without proper heat dissipation and air circulation, system components might overheat, which could lead to reduced lifetime, system failure or even severely damage components.

## WARNING:

- To prevent your product from overheating, do not operate it in an area that exceeds the maximum recommended ambient temperature of 50°C for the GigaCore 16t/18t/20t Range including PoE models.
- The equipment must be installed and protected from rain and humidity.
- Caution, this equipment should be installed in an area where it is unlikely for children to have access to.
- The equipment requires a building installation protection of maximum 20A or less.

## POWER CABLE:

Use only approved power cables. If you have not been provided with a power cable for your system or for any AC powered option intended for your system, purchase a power cable that is approved for use in your country. The power cable must be rated for the product and for the voltage and current marked on the product's electrical ratings label. The voltage and current rating of the cable should be greater than the ratings marked on the product.

## **⚠ WARNING:**

Use a MAINS power-in cable with a maximum length of 3m and a minimum cable section of 1,5mm<sup>2</sup>. If you use the powerCON TRUE 1 - power out to power secondary devices, the circuit needs to be protected by a residual current protective device with rated current not exceeding 30mA.

The total power consumption of the product together with the products connected to the power outlet has to be less than 16A.

## **DISCONNECT DEVICE:**

The powerCON TRUE1 and the DC input for remote power supply, must be accessible at all times, because it serves as the main disconnecting device. Disconnect all power cords during installation of the device.

## **SAFETY CLASSIFICATION OF MAINS POWER INPUT:**

- Mains Input - powerCON TRUE1 inconnection has a safety status of PRIMARY or ES3/PS3 CIRCUIT.
- Mains Output - powerCON TRUE1 out connection has a safety status of PRIMARY or ES3/PS3 CIRCUIT.
- Second PSU port 57V connections have a safety status of ES1/PS3

## **SAFETY CLASSIFICATION OF TRAFFIC PORTS**

- LED extension port has a safety status of EARTHED SELV
- 10/100/1000 Base-T ports have a safety status of UNEARTHED SELV



### **CAUTION/ SHOCK HAZARD**

RISK OF ELECTRIC SHOCK DO NOT OPEN. THIS UNIT HAS ONE AC CONNECTION AND ONE DC INPUT. DISCONNECT ALL CONNECTIONS TO THE POWER SUPPLIES BEFORE SERVICING TO AVOID ELECTRIC SHOCK.

### **ATTENTION/RISQUE D'ÉLECTROCUTION**

**RISQUE DE CHOC ÉLECTRIQUE NE PAS OUVRIR. CETTE UNITÉ  
DISPOSE D'UNE CONNEXION AC ET D'UNE ENTRÉE DC. DÉBRANCHEZ  
TOUTES LES CONNEXIONS AUX ALIMENTATIONS ÉLECTRIQUES  
AVANT L'ENTRETIEN POUR ÉVITER LES CHOCS ÉLECTRIQUES.**



The lightning flash with arrowhead symbol, within an equilateral triangle, is intended to alert the user to the presence of uninsulated “dangerous voltage” within the product’s enclosure that may be of sufficient magnitude to constitute a risk of electric shock to persons.

L'éclair avec une flèche à l'intérieur d'un triangle équilatéral est destiné à attirer l'attention de l'utilisateur sur la présence d'une « tension dangereuse » non isolée à l'intérieur de l'appareil, pouvant être suffisamment élevée pour constituer un risque d'électrocution.



The exclamation point within an equilateral triangle is intended to alert the user to the presence of important operating and maintenance (servicing) instructions in the literature accompanying the appliance.

Le point d'exclamation à l'intérieur d'un triangle équilatéral est destiné à attirer l'attention de l'utilisateur sur la présence d'instructions importantes sur l'emploi ou la maintenance (réparation) de l'appareil dans la documentation fournie.



#### **CAUTION**

TO REDUCE THE RISK OF FIRE OR ELECTRIC SHOCK, DO NOT EXPOSE THIS APPARATUS TO RAIN OR MOISTURE.

NO USER SERVICEABLE PARTS INSIDE. REFER SERVICING TO QUALIFIED SERVICE PERSONEL.

#### **AVERTISSEMENT**

POUR RÉDUIRE LES RISQUES D'INCENDIE OU DE DÉCHARGE ÉLECTRIQUE, N'ÉPOSEZ PAS CET APPAREIL À LA PLUIE OU À L'HUMIDITÉ. AUCUNE PIÈCE CONTENUE À L'INTÉRIEUR NE PEUT ÊTRE RÉPARÉE PAR L'UTILISATEUR, VEUILLEZ CONFIER TOUTE RÉPARATION À UN PERSONNEL QUALIFIÉ.

This unit has more than one power supply.

Disconnect all supplies before servicing to avoid electric shock.

Cet appareil comporte plus d'un cordon d'alimentation,

Afin de prévenir les chocs électriques, débrancher les cordons d'alimentation avant le dépannage.

**FCC Compliance Statement:**

This device complies with Part 15 of the FCC Rules. Operation is subject to the following two conditions: (1) this device may not cause harmful interference, and (2) this device must accept any interference received; including interference that may cause undesired operation.

**⚠ IMPORTANT NOTICE:  
DO NOT MODIFY THIS UNIT!**

This product, when installed as indicated in the instructions contained in this manual, meets FCC requirements. Modifications not expressly approved by Luminex Lighting Control Equipment nv may void your authority, granted by the FCC, to use the product.

This Equipment has been tested and found to comply with the limits for a Class A digital device, pursuant to Part 15 of the FCC rules. These limits are designed to provide reasonable protection against harmful interference when the equipment is operated in a commercial environment. This equipment generates, uses and can radiate radio frequency energy and, if not installed and used in accordance with the instructions, may cause harmful interference to radio communications. Operation of this equipment in a residential area is likely to cause harmful interference in which case the user will be required to correct the interference at his own expense.

**Industry Canada compliance statement**

This Class A digital apparatus complies with Canadian ICES-003.

Cet appareil numérique de la classe A est conforme à la norme NMB-003 du Canada.

**European Community Compliance Statement**

This is a class A product. In a domestic environment, this product may cause radio interference in which case the user may be required to take adequate measures.



## **Disposal of Waste Equipment by users in the European Union**

### **Information for Users on Collection and Disposal of Old Equipment**

This symbol on the products, packaging, and/or accompanying documents means that used electrical and electronic products should not be mixed with general household waste. For proper treatment, recovery and recycling of old products, please take them to applicable collection points, in accordance with your national legislation and the Directives 2002/96/EC. By disposing of these products correctly, you will help to save valuable resources and prevent any potential negative effects on human health and the environment which could otherwise arise from inappropriate waste handling. For more information about collection and recycling of old products, please contact your local municipality, your waste disposal service or the point of sale where you purchased the items.

### **[For business users in the European Union]**

If you wish to discard electrical and electronic equipment, please contact your dealer or supplier for further information.

### **[Information on Disposal in other Countries outside the European Union]**

This symbol is only valid in the European Union. If you wish to discard these items, please contact your local authorities or dealer and ask for the correct method of disposal.

---



# QUICKSTART GUIDE

Welcome to your GigaCore 16t/18t/20t.

Upon unpacking your new GigaCore, the E-ink display will display a QR-code. After scanning this QR-code, the safety manual and quick start guide will be opened on the device used for scanning. Once the device has been powered up and booted, this QR-code will disappear and not come back on a following bootup.

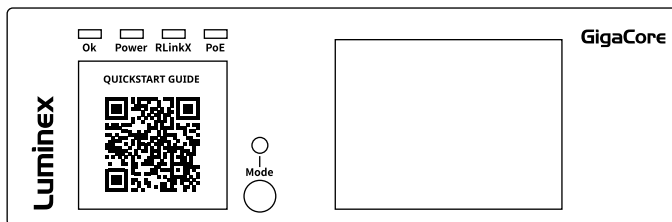

The complete user manual can be found in the download section of our website: [www.luminex.be/support-2/product-downloads](http://www.luminex.be/support-2/product-downloads)

# 1. MOUNTING THE DEVICE

## 1.1 Rack mount

In case you want to mount your GigaCore 16t/18t/20t in a standard 19-inch rack, you need 4 rack screws to mount the device.

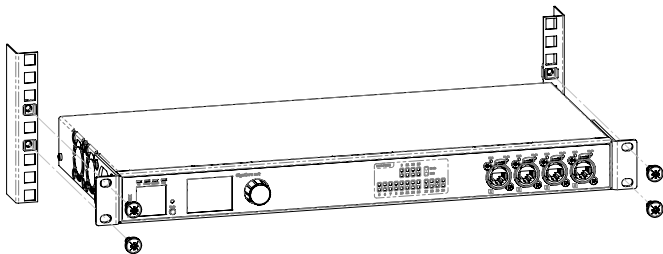

# 2. POWER UP THE DEVICE

Power-up the device by connecting a power cable (**J**) (please contact your local dealer if you don't have a suitable power cable on hand). The device will automatically switch on. To shut it down after use, just un-plug the power cable again.



After connecting the power cable correctly, the power LED indicator on the front panel will light up green. The GigaCore 16t/18t/20t requires standard AC power 100-240VAC, 50/60Hz. Current required depends on the model. Please use a powerCON TRUE 1 compliant cable to power the device.

## 3. DESCRIPTION

### 3.1 Front Panel

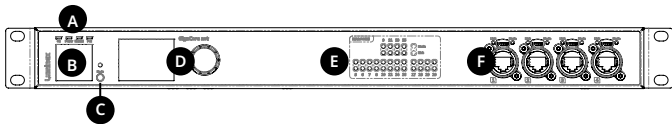

#### (A) Status LEDs:

- **OK:** Indicates the general status of the switch.
- **PoE:** Indicates the status of the PoE functionality and the PoE supplies (GigaCore 16t/18t/20t with PoE only).
- **RLinkX:** Indicates the RLinkX status.
- **Power:** Indicates the status of the power supply.

#### (B) E-ink Display:

- **E-ink display:** Indicates the options the switch has been equipped with and the IP address (can be disabled in the settings).

#### (C) Mode:

- **Mode LED:** Indicates the selected state for the Mode LEDs (see the “LED indicators” section in this manual for more details).
- **Mode button:** Use this button to cycle through the different states of the port Mode LEDs.

#### (D) LCD and jog wheel:

- Navigate and configure your 20t switch using the LCD and jog wheel.

#### (E) Representation of the rear ports:

- Shows the mode and link activity of the rear ports on the front panel.

#### (F) EtherCON ports :

- 4 x 1Gbps EtherCON

### 3.2 Rear Panel

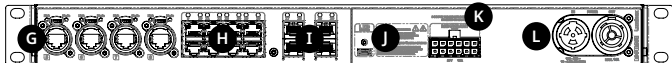

#### (G) EtherCON ports :

- 4 x 1Gbps EtherCON

#### (H) RJ45 Ports:

- 8 x 1Gbps RJ45

#### (I) SFP:

- 4 x SFP+

#### (J) LED Extension Port:

- 1x LED extension port for optional LED panel on USB-C.

#### (K) Second PSU:

- **DC input** for remote power supply (15A)

#### (L) Power input - Mains outlet:

- **AC power** 100-240VAC, 10 - 4,2A, 50/60Hz.
- **Mains outlet** 14A max.

## 4. LED INDICATORS

There are various LEDs on the GigaCore 16t/18t/20t. Here is a list of the LEDs, the possible colours, and the meaning of each colour:

SWITCH LED	COLOUR	DESCRIPTION
OK (General status)	Green	All OK
	Green flashing	Unit is writing to the flash. Do NOT disconnect power.
	Orange	Temperature warning.
	Red flashing	Temperature or Fan error.
	Red/Green flashing	The unit is flashing firmware. Do NOT disconnect power.
PoE LED (GigaCore 16t/18t/20t with PoE only)	Green	Redundant mode with Second PSU connected.
		Shared mode
	Orange	Redundant mode without RPSU
	Red	PSU error.
PoE port error.		
RLinkX	Green	RlinkX is active. (with future firmware version)

SWITCH LED	COLOUR	DESCRIPTION
Power LED	Green	Normal operation by non PoE / Second PSU connected and powered with PoE models
	Orange	No second PSU connected for PoE models
	Red flashing	Second PSU connected but no mains connected. PSU error.

PORT LED	STATUS	DESCRIPTION
Link	Off	No Link
	Green	Gigabit connection
	Orange	10/100 Mbps connection
	Blink	Activity

With the use of the mode button, the user can get all the necessary information immediately. Press the mode button to cycle through the different states.

STATE	MODE LED	PORT MODE LED	DESCRIPTION
Groups	White	Group Colour	The LED colour indicates the group assignation of the port.
PoE	Yellow	Yellow	PoE is activated on this port.
		Orange	Port is sourcing PoE to a device.
		Red	Error with PoE.
Dark Mode	Off	Off	All port LEDs are switched off. Switch status LEDs remain available.

## 5. INSTALLING SFP+ TRANSCEIVERS

The GigaCore 20t and GigaCore 18t are equipped with SFP+ cages at the rear of the unit. Use with IEC 60825-1 Certified SFP+ transceivers only.

- 1 Insert the transceiver entirely into the SFP+ cage gently applying just enough pressure until the module locks in place with an audible “click”. Once properly engaged, the transceiver can’t be removed unless the delatch mechanism is engaged.

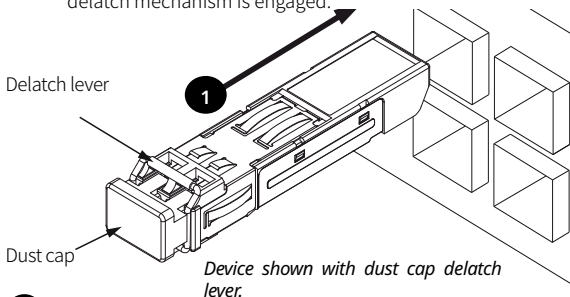

2

Be aware of the insertion direction:

Top ports must have the delatch lever on the top.

Bottom ports must have the SFP+ transceiver inserted **UPSIDE-DOWN** (delatch lever on bottom).

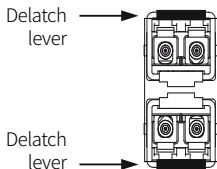

- 3** Open the lever to disengage and remove the SFP+ transceiver.

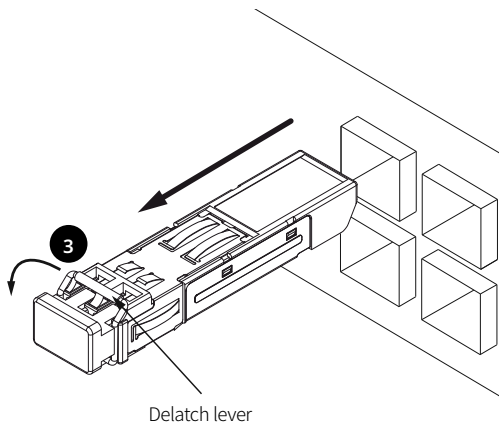

For any other model of SFP+ transceiver, please refer to the transceiver manual.

For recommended transceivers please visit our website at: [www.luminex.be](http://www.luminex.be)



## 6. CONNECTING TO THE WEB INTERFACE

- The default GigaCore IP address is displayed on the e-ink display and at the rear of the unit. Set your computer with a compliant IP address (do not use the same IP address!).
- Connect your computer to the GigaCore with a network cable.
- Launch your favourite web browser.
- Type the IP address of the switch in the address field followed by enter.



**PLEASE KEEP IN MIND THE WEB INTERFACE OF A SWITCH CAN ONLY BE REACHED THROUGH A PORT ASSIGNED IN THE MANAGEMENT GROUP (FROM THE SWITCH YOU'RE CONNECTED TO, OR FROM ANOTHER SWITCH THROUGH AN ISL PORT). YOU NEED AT LEAST ONE PORT ASSIGNED TO THE MANAGEMENT GROUP IN YOUR ENTIRE NETWORK TO REACH THE WEB INTERFACE OF ALL YOUR GIGACORE SWITCHES**

**BY FACTORY DEFAULT, ALL PORTS ARE ASSIGNED TO THE MANAGEMENT GROUP.**

## 7. RESET

Sometimes it can come in handy to reset the device. To do this, press and hold the mode button for 10 seconds. Once the four status LEDs blink red, release the button. This will reset all settings to default. The user profiles will be preserved though.

## 8. TECHNICAL SUPPORT

Sometimes it is required to get more help with your device or application. There is a knowledge base available online that gets updated on a regular basis at: <https://support.luminex.be>

If you need to ask our team for more help or you need to return a device to Luminex for diagnostics or repair, you can also find the option on this page to request an RMA or start a support ticket.

## **DISCLAIMER**

Luminex LCE maintains a policy of continuous development. Luminex LCE reserves the right to make changes and improvements to any of the products described in this document above without prior notice. Specifications are subject to change without notice.

Copyright © 2002-2023.

All rights reserved.

No part of this documentation may be reproduced or transmitted in any form or by any means, electronically or physically, including photocopying and recording, without the prior written permission of Luminex. The information in this documentation is supplied without warranty of any kind, either directly or indirectly, and is subject to change without prior written notice. Luminex, its employees or appointed representatives will not be held responsible for any damages to software, hardware, or data, howsoever arising as a direct or indirect result of the product(s) mentioned herein.



**LUMINEX**

Slamstraat 13 | 3600 Genk | Belgium | T +32 11 812 189  
info@luminex.be | www.luminex.be