

SCENA LED 80 WHITE



SCENA LED 80 PC



SCENA LED 80 FR

User's Manual rel E.13 **GB**

D.T.S. Illuminazione s.r.l. – ITALY
<http://www.dts-lighting.it/>



The Lighting Company

Made in Italy

Le informazioni contenute in questo documento sono state attentamente redatte e controllate. Tuttavia non è assunta alcuna responsabilità per eventuali inesattezze. Tutti i diritti sono riservati e questo documento non può essere copiato, fotocopiato, riprodotto per intero o in parte senza previo consenso scritto della D.T.S .

D.T.S. si riserva il diritto di apportare senza preavviso cambiamenti e modifiche estetiche , funzionali o di design a ciascun proprio prodotto. D.T.S non assume alcuna responsabilità sull'uso o sull'applicazione dei prodotti o dei circuiti descritti.

The information contained in this publication has been carefully prepared and checked. However, no responsibility will be taken for any errors. All rights are reserved and this document cannot be copied, photocopied or reproduced, in part or completely, without prior written consent from D.T.S.

D.T.S. reserves the right to make any aesthetic, functional or design modifications to any of its products without prior notice. D.T.S. assumes no responsibility for the use or application of the products or circuits described herein.

Les informations contenues dans le présent manuel ont été rédigées et contrôlées avec le plus grand soin. Nous déclinons toutefois toute responsabilité en cas d'éventuelles inexactitudes. Tous droits réservés. Ce document ne peut être copié, photocopié ou reproduit, dans sa totalité ou partiellement, sans le consentement préalable de D.T.S.

D.T.S. se réserve le droit d'apporter toutes modifications et améliorations esthétiques, fonctionnelles ou de design, sans préavis, à chacun de ses produits. D.T.S. décline toute responsabilité sur l'utilisation ou sur l'application des produits ou des circuits décrits.

Las informaciones contenidas en este documento han sido cuidadosamente redactadas y controladas. Con todo, no se asume ninguna responsabilidad por eventuales inexactitudes. Todos los derechos han sido reservados y este documento no puede ser copiado, fotocopiado o reproducido, total o parcialmente, sin previa autorización escrita de D.T.S.

D.T.S. se reserva el derecho a aportar sin previo aviso cambios y modificaciones de carácter estético, funcional o de diseño a cada producto suyo. D.T.S. no se asume responsabilidad de ningún tipo sobre la utilización o sobre la aplicación de los productos o de los circuitos descritos.

INDEX:

1-SYMBOLS.....	4
2-GENERAL WARNING	4
3-GENERAL WARRANTY CONDITIONS.....	4
4-TECHNICAL FEATURES	5
5-ACCESSORIES	6
6-IMPORTANT SAFETY INFORMATION.....	7
6.1 Fire prevention.....	7
6.2 Prevention of electric shock.....	7
6.3 Safety	7
6.4 Waste Electrical and Electronic Equipment directive.....	7
7-INSTALLATION	8
8-INPUT / OUTPUT CONNECTIONS.....	9
9-DMX SIGNAL CONNECTION	10
9.1 DMX addresses.....	11
9.2 Selecting the DMX address	11
10-FIRMWARE UPDATING	11
11-DISPLAY FUNCTIONS	12
12-DMX PROTOCOL	16

1- SYMBOLS

Graphic symbols used on this manual:



THIS SYMBOL INDICATES A HOT SURFACE



THIS SYMBOL INDICATES ELECTRIC SHOCK RISK



THIS SYMBOL INDICATES GENERAL RISK

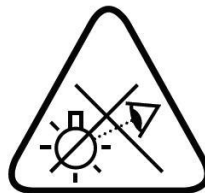

THIS SYMBOL MEANS “DO NOT STARE AT THE OPERATING LIGHT SOURCE”



THIS SYMBOL INDICATES THE EUROPEAN COMMUNITY DIRECTIVE 2002/96/EC ON WASTE ELECTRICAL AND ELECTRONIC EQUIPMENT (WEEE)

2- GENERAL WARNING

Read the instruction contained in this user manual carefully, as they give important information regarding safety during installation , use and maintenance.

The unit is not for residential use and must be installed by a qualified electrician or experienced person.

Always disconnect the device from the mains before maintenance.

The device must always be equipped with an efficient ground connection.

3- GENERAL WARRANTY CONDITIONS

The unit is guaranteed for 36 months from the date of purchase against manufacturing material defects.

4- TECHNICAL FEATURES

OVERVIEW

SCENA LED 80 WHITE is a compact, lightweight, DMX-controlled projector featuring a single high-power LED, and a wide excursion zoom, enabling it to be used as a PC Beam or a very wide Wash.

SCENA LED 80 WHITE is a modern alternative to conventional lights, improving light quality, flexibility of use and installation, energy savings and component duration.

In fact the fixture doesn't heat up, and the projection is always flicker free.

Also, the dimming curves are similar to those of halogen lamps.

LED Technology

1 x White LED (3000K), 7700 lm, CRI>90; 4000K and 5000K also available (2700K, 5600K or 6500K on request)

Optical group

PC version: Ø90 mm PC lens, 10°-76° linear zoom

FR version: Ø112mm Fresnel lens, 14° - 77° linear zoom

Control

2 DMX channels (default)

4 digit 7 segments display + 4 soft keys

Connection

Power supply: POWERCON In/Out panel connectors

DMX: XLR 5 poles In/Out panel connectors

Power supply

Electronic full-range 100-240Vac 50-60 Hz

Consumption: 100W Max

Weight

3,7 Kg

International certifications



2006/95/CE ; 2004/108/CE
IEC 62471 ; IEC 695-2-1

EN 60598-1 ; EN 62471 ; EN 61347-2-13
EN 60598-2-17 ; EN 55015 EMC ; EN 61347-1



Conforms to UL Std. 1573; Cert. to CSA Std. C22.2 No.166.

Intertek
5000116

DIMENSIONS

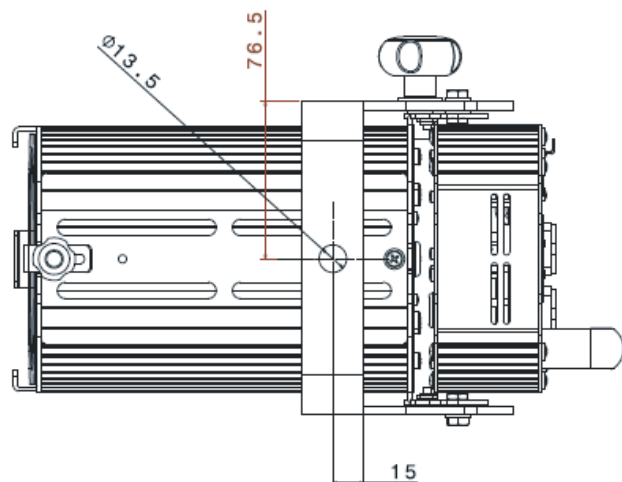
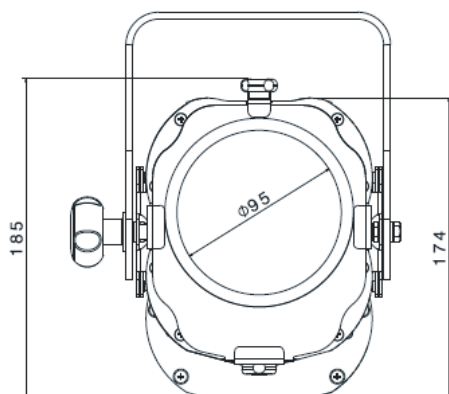
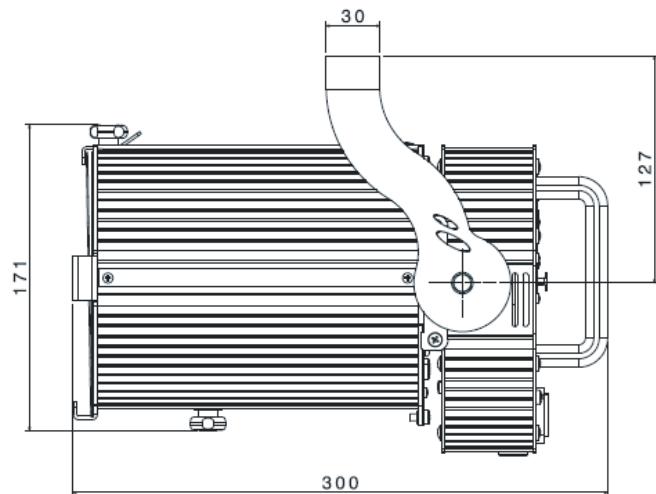
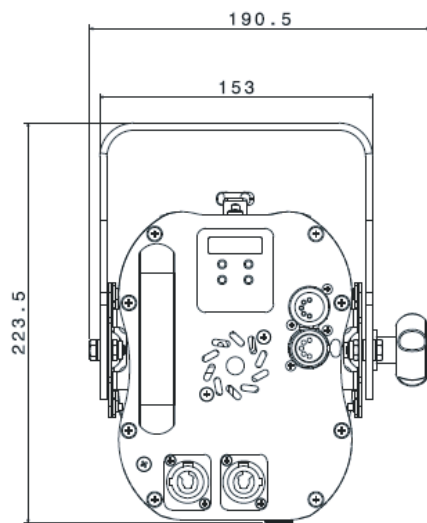

5- ACCESSORIES

As standard

- 1 x User's Manual
- 1 x POWERCON male cable connector (D.T.S. Code 0520P014)
- 1 x XLR 5 pins male cable connector (D.T.S. Code 0508B028)
- 1 x XLR 5 pins female cable connector (D.T.S. Code 0508B027)
- 1 x Filterframe for SCENA COMPACT *Black finish (D.T.S. Code 02M00422.46)

Optional (on request)

- "C" Clamp G50 (Max. Load. 10 Kg) *Black finish (D.T.S. Code 0521A012)
- "C" Clamp G60 (Max. Load. 50 Kg) *Black finish (D.T.S. Code 0521A004)
- Safety cable 3 mm x 60 cm, max capacity load 60 Kg (D.T.S. Code 0521A010)
- Barndoor for SCENA COMPACT *Black finish (D.T.S. Code 03.TA206)

6- IMPORTANT SAFETY INFORMATION

6.1 Fire prevention:

Replace any blown or damaged fuses only with those of identical value (2AT).

6.2 Prevention from electric shock:



High voltage is present inside the unit. Unplug the unit prior to performing any operation which involves touching the inside of the unit.
 This equipment must be grounded, do not connect to non-grounded supplies.
 The use of a thermal magnetic circuit breaker is recommended for each SCENA LED 80 unit. Use only AC supplies 100-240V 50-60 Hz.
 SCENA LED 80 should never be located in position exposed to rain or in areas of extreme humidity.
 A good air ventilation is essential for proper equipment work.

6.3 Safety:



The unit is not for residential use and must be installed by a qualified electrician or experienced person.

Do not stare at the operating light source.



The luminaire should be positioned so that prolonged staring into the luminaire at a distance closer than 3.7 m is not expected.

The light source contained in this luminaire shall only be replaced by the manufacturer or his service agent or a similar qualified person.

The external surface of the unit may exceed 50°C; never handle the unit until at least 5 minutes have elapsed since the unit was turned off.



Never install the unit in an enclosed area lacking sufficient air flow.

The ambient temperature should not exceed 40°C and should not be lower than -10°C.

6.4 Waste Electrical and Electronic equipment (WEEE) directive:



The unit, accessories and packaging should be sorted for environmental-friendly recycling.

For EC countries: according to the European Directive 2002/96/EC for Waste Electrical and Electronic Equipment and its implementation into national right, luminaires that are no longer usable must be collected separately and disposed of in an environmentally correct manner.

7- INSTALLATION

The unit is suitable for dry locations only.

SCENA LED 80 can be installed on a truss or on the ceiling.

It is recommend the use of appropriate clamps to fix the unit to the mounting surface.

ATTENTION:

A safety cable (code 0521A010) must be securely fixed to the unit's mounting bracket and to the support structure of the projector as showed in the picture below.

Fixing clamps and safety cable are available on request.

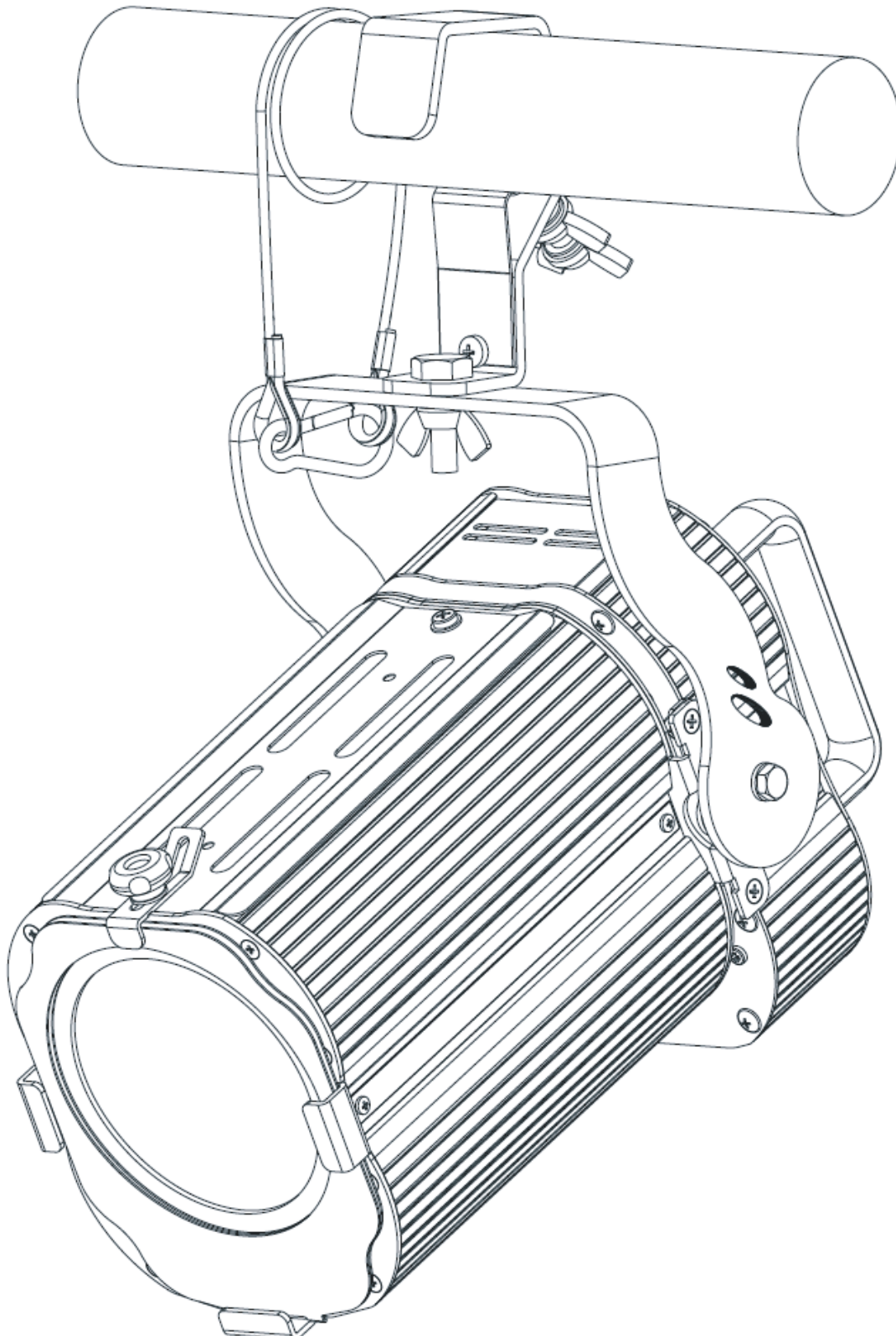

8- INPUT / OUTPUT CONNECTIONS

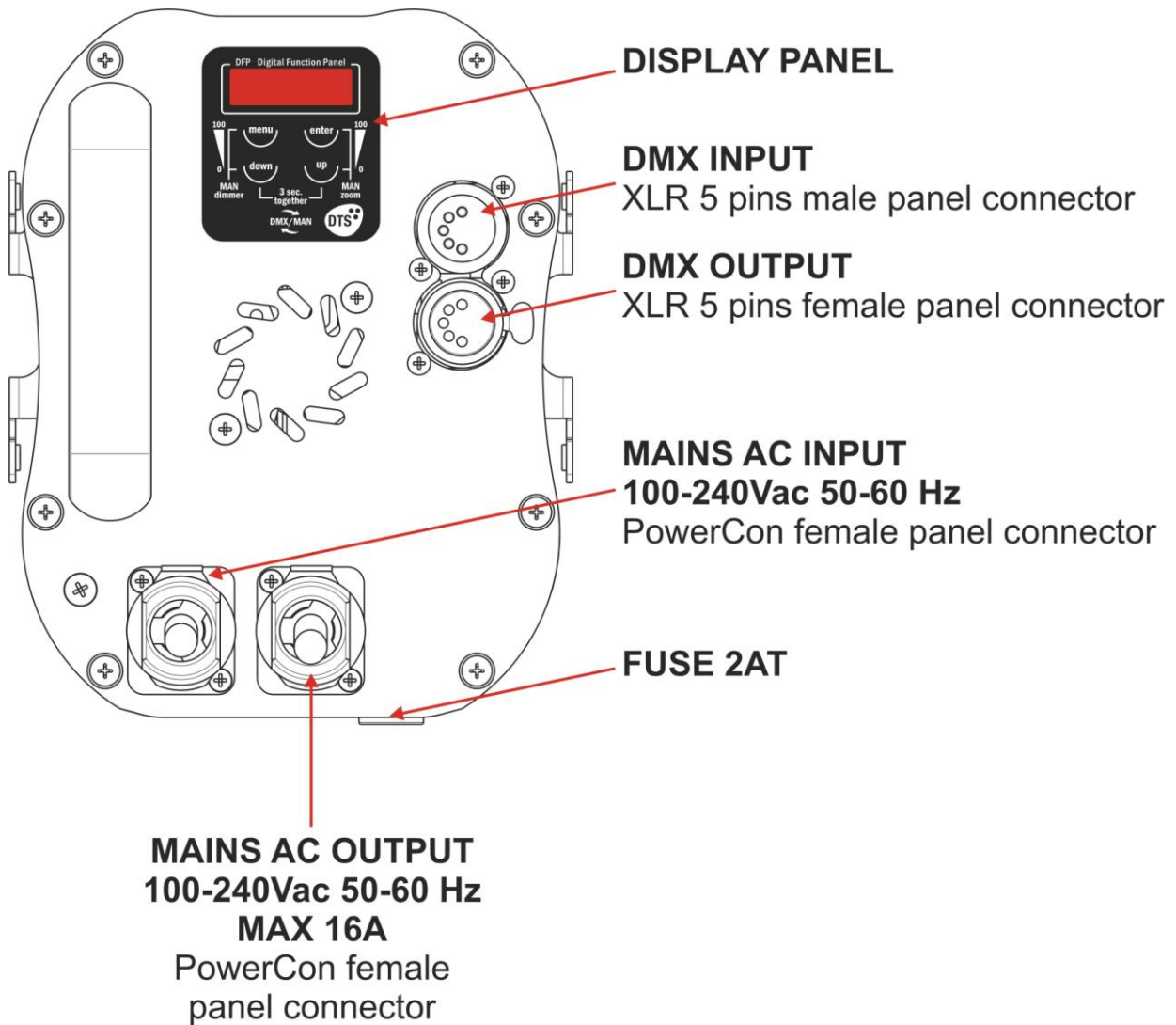

9- DMX SIGNAL CONNECTION:

The unit operates using a digital DMX 512 signal.

Connection between the controller and the unit or between units must be carried out using a two pair screened \varnothing 0.5 mm.

Ensure that the conductors do not touch each other.

Do not connect the cable ground to the DMX connector chassis.

The plug housing must be isolated. Connect the mixer signal to the DMX IN projector plug and connect it to the next projector by connecting the DMX OUT plug on the first unit to the DMX IN plug of the second one.

In this way, all the projectors are cascade connected.

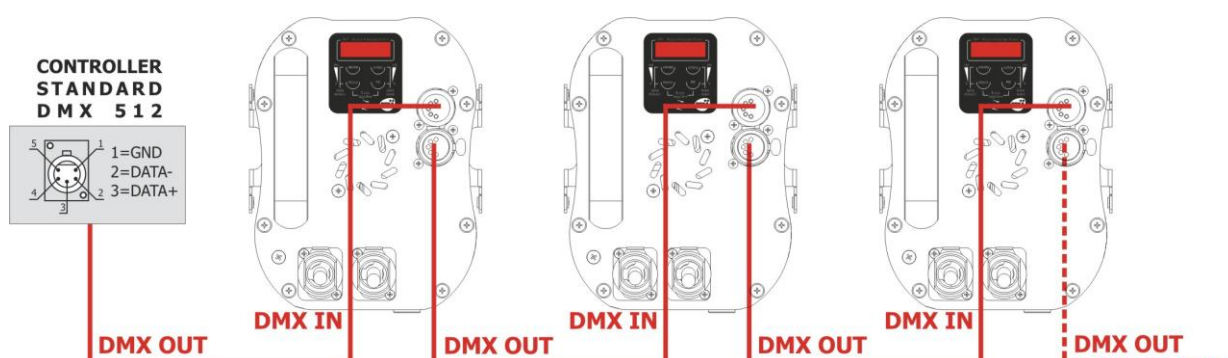

If the display showing the DMX address flashes, then one of the following errors has occurred:

- DMX signal not present
- DMX reception problem

For Installations where long distance DMX cable connections are needed, we suggest to use a DMX terminator.

The DMX terminator is a male XLR 3-5 pins connector with a 120 ohm resistor Between pin 2 and 3.

The DMX terminator must be plugged into the last unit (DMX out panel connector) of the DMX line.

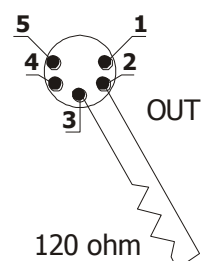

PLACE A 120 OHM RESISTOR BETWEEN PIN 2 AND 3 OF A MALE XLR CONNECTOR AND PLUG IT INTO THE DMX OUT PANEL CONNECTOR OF THE LAST UNIT CONNECTED TO THE DMX LINE

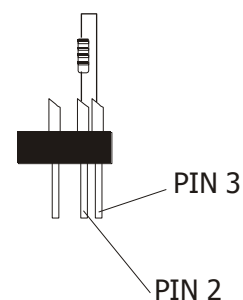

9.1 DMX addresses

SCENA LED 80 FR can be controlled with 2 DMX channels (default), 3 DMX channels or 1 DMX channel.

In order to use the unit in 2 DMX channels mode, set the following addresses on the mixer:

Projector 1	A001	
Projector 2	A003	If you want to select the next projector, just add "2"
Projector 3	A005	
.....	A....	
projector 6	A011	

9.2 Selecting the DMX address

- 1) Press the UP-DOWN key until you reach the required DMX address. The numbers on the display will start to flash (but the new DMX address hasn't yet been set).
- 2) Press ENTER to confirm your selection. The numbers on the display will stop flashing and the projector is now controlled by the new DMX address.

TIPS: if you keep pushed the UP or DOWN keys, the channels are calculated more quickly and you get a faster selection.

- 2) Press ENTER to confirm your selection. The numbers on the display will stop flashing and the projector is now controlled by the new DMX address.

10- FIRMWARE UPDATING

To update the software version of the SCENA LED 80 you need:

- D.T.S. RED BOX interface (D.T.S. Code: 03.LA.008)
- USB-DMX Driver for the D.T.S. RED BOX interface
- "D.T.S. Firmware upgrade utility" program installed on PC
- Latest firmware release available for SCENA COMPACT LED 50 unit

Updating the software version.

Please follow the procedure below to perform the update:

1. Install the D.T.S. RED BOX USB-DMX driver on the PC you will use to update the unit software.
2. Connect the D.T.S. RED BOX interface to the PC by using a USB cable.
3. Connect the D.T.S. RED BOX interface to the fixture by using a DMX cable.
4. Send the new software version into the unit by using "D.T.S. Firmware upgrade Utility" program.

11- DISPLAY FUNCTIONS

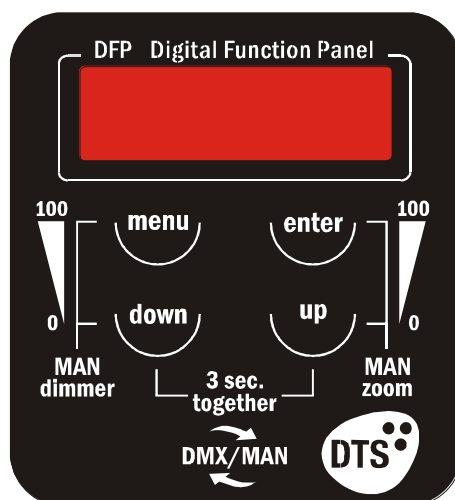















DISPLAY FUNCTIONS











The SCENA LED 80 display panel shows all the available functions.

Using these functions, it is possible to change some of the parameters and add some functions. Changing the D.T.S. setting can vary the functions of the unit so that it does not respond to the DMX 512 used to control it. Carefully follow the instructions below before carrying out any variations or selections.

NOTE: the symbol  shows which key has to be pushed to obtain the desired function.

Software version 1.06

  A001	  DISP	  Pos1	 AA	Floor Position	
REVERSE DISPLAY Reverses display's reading depending on the mounting position (on the ground or suspended).		 Stby	  off	Suspended Position	
DISPLAY STAND BY To turn off the display (after 5 seconds) Or leave it always on.			 on	Display Off	
				Display Always on	

  mode	  2ch	 2 Channels
	 1ch	1 DMX channel mode
	 3ch	3 DMX channels mode
DMX MODE To select DMX mode : 2 DMX channels mode (default), 1 DMX channel mode, 3 DMX channels mode or Manual mode. Manual mode can also be activated by pressing at the same time the "UP" + "DOWN" buttons on unit display for 3 seconds ("A001").	 MAN	 SURE
		 Manual Mode



LED



Min

Default = 0

**LED**

Led Min/Max, Smooth, Compression, Sync and Boost level values settings



MAX

Default = 100

**LED MINIMUM VALUE**

This menu allows to select the minimum levels for white



SMTH



4

Range = Off-20
Default = 4

**LED MAXIMUM VALUE**

This menu allows to select the maximum levels for white



COMP



QUAD

Quadratic =
Linear light
output



LINE

Linear = Linear
Current output



Sync



610

Range =
610 Hz – 10 KHz
Default = 610 Hz



bst



on

Boost mode
activated



off

Boost mode
deactivated



These settings have priority on Master Dimmer channel

SMOOTH VALUE

This menu allows to select the value of the delay (in milliseconds) for Dimmer channel reaction to DMX or Program variation.

Off = 25 ms. Instant response to DMX variation.

20 = 250 ms. Smooth response to DMX variation.

With BOOST active, the LED'S current is set to Max value.
(30% more gain compared to BOOST Off)
Default = Disabled

COMPRESSION

This menu allows to select between Linear current output or Quadratic current output for LEDs
Default = Quadratic

SYNC

This menu allows to adjust the PWM frequency value (Hz) in order to reduce flickering in the process of your camera recordings

BOOST DRIVING

This menu allow to increase the LED's current from Min to Max



dimm



255

**DIMMER**

Dimmer intensity level (range 0-255)

Active only if MODE = 1 DMX channel mode



ir



off



on



Note:
External infrared remote sensor needed (D.T.S. Code: 03.LA.016)

INFRARED MODE

Infrared remote control.

By activating Ir Mode, it will be possible to navigate through the unit functions by using the D.T.S. infrared remote control
(D.T.S. Code: 0514L008)

NOT IMPLEMENTED ON SCENA LED 80



UDNH



SEL



off



Wireless Enabled

WIRELESS DMX

Wireless DMX enabled / disabled.

By activating WDMX MODE, it will be possible to control SCENA LED 80 via D.T.S. ANTENNA Wireless DMX Transmitter (cod. 03.E1271).

Active only on SCENA LED 80 with Wireless on board

on



Wireless Disabled

UnLH



UNLINK = LOG OUT

Logging on SCENA LED 80 (WIRELESS DMX must be enabled on SCENA LED 80 unit)



To log on the SCENA LED 80 in the WIRELESS system simply press and quickly release the function button on the transmitter.

The transmitter will start flashing rapidly red/green scanning for new free receivers / SCENA LED 80 units.

When a SCENA LED 80 logs on to the transmitter the LINK green light on transmitter starts to flash rapidly.

After approximately 10 seconds the transmitter will jump back to normal mode and continue transmitting data.

The SCENA LED 80 now try to synchronize to the transmitter.

When synchronized to the transmitter, 2 different modes are possible:

1. Antenna transmitter has detected and transmits a DMX signal, in this mode a solid green light is seen on the transmitter and solid display is seen on SCENA LED 80.
2. No DMX signal connected, the Antenna transmitter will flash red/green; display blinking on SCENA LED 80.

To log SCENA LED 80 off from a transmitter simply select UNLINK function  under WIRELESS

DMX MENU  and press ENTER.

When SCENA LED 80 is logged off, the display is blinking, meaning its available for log in on a new transmitter.

Logging out a SCENA LED 80

Select UNLINK function  under WIRELESS DMX MENU  and press ENTER.

When SCENA LED 80 is logged off the display is blinking, meaning its available for log in on a new transmitter.

Logging out all SCENA LED 80 units linked to a transmitter

Press and hold the function button of the transmitter for about 3 seconds. When the display is blinking on SCENA LED 80, it mean that the units are logged out.

Transmitter, Status LED

Flashing red/green, no dmx connected.

Solid green, dmx signal detected and transmitted.

Fast flashing red/green, log in mode (every free SCENA LED 80 unit, not logged in to any other transmitter, will be logged on)

SCENA LED 80 Status

Display blinking = not logged on to a transmitter (free).

Solid display = logged on to a transmitter and receiving dmx data.



ENER



SEL



off



Default = OFF

EMERGENCY

Emergency operating mode.
By setting Emergency mode, it will be possible to select Dimmer intensity level that will then ran if DMX signal is missing or not available.
Usefull for Emergency EXIT illumination on public areas.

on



dim



Default = 204 (80%)



dfse



sure



DEFAULT SETTING

To restore default settings



temp



0250



TEMPERATURE

LED Driver board and external unit temperature visualisation



time



LED



LIFE TIME

This menu show the total unit life time and the LED life time

Unit



Soft



v.1.22

SOFTWARE

Software version

12- DMX PROTOCOL**2 CHANNELS MODE (Default)**

- 1 **SHUTTER / STROBE**
 2 **DIMMER**

DMX CHANNEL	1	Parameter: SHUTTER / STROBE
-------------	---	------------------------------------

DMX range Value	Mid Point DMX value	Move Range (degrees)	Mode	Option	Function
000-009					Black-out
010-019					Open
020-029					Black-out
030-119					Strobe (from 3.27 s to 30 ms)
120-149					Pulse up (from 42.6 s to 120 ms)
150-179					Pulse down (from 42.6 s to 120 ms)
180-204					Random strobe (Dimmer channel active)
205-229					Full independent Random Strobe (Dimmer channel disabled)
230-255					Open

DMX CHANNEL	2	Parameter: DIMMER
-------------	---	--------------------------

DMX range Value	Mid Point DMX value	Move Range (degrees)	Mode	Option	Function
000-255					Proportional dimmer

1 CHANNEL MODE

- 1 **DIMMER**

DMX CHANNEL	1	Parameter: DIMMER
-------------	---	--------------------------

DMX range Value	Mid Point DMX value	Move Range (degrees)	Mode	Option	Function
000-255					Proportional dimmer

3 CHANNELS MODE

- 1 SHUTTER / STROBE
- 2 DIMMER
- 3 DIMMER FINE

DMX CHANNEL	1	Parameter: SHUTTER / STROBE
-------------	---	------------------------------------

DMX range Value	Mid Point DMX value	Move Range (degrees)	Mode	Option	Function
000-009					Black-out
010-019					Open
020-029					Black-out
030-119					Strobe (from 3.27 s to 30 ms)
120-149					Pulse up (from 42.6 s to 120 ms)
150-179					Pulse down (from 42.6 s to 120 ms)
180-204					Random strobe (Dimmer channel active)
205-229					Full independent Random Strobe (Dimmer channel disabled)
230-255					Open

DMX CHANNEL	2	Parameter: DIMMER
-------------	---	--------------------------

DMX range Value	Mid Point DMX value	Move Range (degrees)	Mode	Option	Function
000-255					Proportional dimmer

DMX CHANNEL	3	Parameter: DIMMER FINE
-------------	---	-------------------------------

DMX range Value	Mid Point DMX value	Move Range (degrees)	Mode	Option	Function
000-255					Proportional dimmer

NOTES

NOTES

The information contained in this publication has been carefully prepared and checked. However, no responsibility will be taken for any errors. All rights are reserved and this document cannot be copied, photocopied or reproduced, in part or completely, without prior written consent from D.T.S.

D.T.S. reserves the right to make any aesthetic, functional or design modifications to any of its products without prior notice. D.T.S. assumes no responsibility for the use or application of the products or circuits described herein.

MADE IN ITALY



The Lighting Company

ISO 9001:2008

D.T.S. quality system
is certified to the
ISO 9001:2008 standard



D.T.S. products are designed
and manufactured at the D.T.S.
plants in Italy



05171243.ETL

D.T.S. Illuminazione s.r.l. – Via Fagnano Selve 10-12-14 47843
Misano Adriatico (RN) Italia
Tel.: +39 0541 611131. Fax + 39 0541 611111
info@dts-lighting.it www.dts-lighting.it